











CONTROL & STEERING CABLES

UNIVERSAL CONTROL CABLE SELECTION CHART

Universal Type Cables **(XX) Indicate the cable length you require in feet - AQMC8(08) = AQMC8 (8ft cable)**

		AQMC8XX		
Type AQMC8 - Standard Duty	Cable Travel 3"	Thread Size 10-32" UNF	Lengths available 5ft - 30ft	
Mid range cable for longer more complicated routes				

		AQMC22XX		
Type AQMC22 - Heavy Duty	Cable Travel 3"	Thread Size 1/4"-28" UNF	Lengths available 10ft - 32ft	
Heavy duty applications				

How to measure for a Replacement Control Cable Control cable length in feet. Round up up to next even foot.

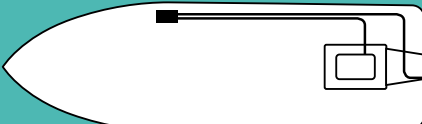
	
For new installation Outboards Cable length: measure cable path, add 3ft for engine loop. Round up to next even foot.	For new installation Sterndrive Inboards Typical stern drive inboard control cable routing. Cable length: measure cable path and round up to next even foot.

For Replacement of Existing Cable:

If you have removed the old cable, measure the cable as follows: from tip to tip and round up to the next foot. The control cable part number contains its length. AquaFlex cables are usually listed as **AQMC??XX**, where **XX** = length in feet. FOR EXAMPLE: Part Number **AQMC828** = 28 ft.

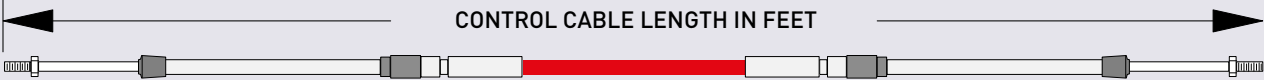

CONTROL CABLE LENGTH IN FEET

AquaFlex C8 Standard Engine Control Cable

- ◆ Single steering station only
- ◆ Engine control cables for use with all inboard and the following sterndrive and outboard engines
Sterndrive: Volvo Penta, Yanmar, Volkswagen
Outboards: Force, Selva, Yamaha, Suzuki, Tohatsu, Honda, Nissan
- ◆ Conduit OD: 8.7mm
- ◆ Thread end: 10-32 UNF
- ◆ Outer casing: 8.5mm
- ◆ Jacket colour: Red
- ◆ Stroke: 87mm (3.4")
- ◆ Lengths available: 5ft (1.52m) to 30ft (9.14m)

Length		Part No:
(ft)	(m)	
5	1.52	AQMC805
6	1.82	AQMC806
7	2.13	AQMC807
8	2.4	AQMC808
9	2.74	AQMC809
10	3.04	AQMC810
11	3.35	AQMC811
12	3.65	AQMC812
13	3.96	AQMC813
14	4.26	AQMC814
15	4.57	AQMC815
16	4.87	AQMC816
17	5.18	AQMC817
18	5.48	AQMC818
19	5.79	AQMC819
20	6.09	AQMC820
21	6.40	AQMC821
22	6.70	AQMC822
23	7.01	AQMC823
24	7.31	AQMC824
25	7.62	AQMC825
26	7.92	AQMC826
27	8.22	AQMC827
28	8.53	AQMC828
29	8.83	AQMC829
30	9.14	AQMC830



AquaFlex C22 Heavy Duty Engine Control Cable

- ◆ Single and dual steering stations
- ◆ Stainless steel clamp fittings, recommended for heavy duty commercial applications where push-pull loads are more severe
- ◆ Conduit OD: 11mm
- ◆ Thread end: 1/4" x 28 UNF
- ◆ Outer casing: 10mm
- ◆ Jacket colour: Red
- ◆ Stroke: 80mm (3.1")
- ◆ Lengths available: 10ft (3.04m) to 32ft (9.75m)













Length		Part No:
(ft)	(m)	
10	3.04	AQMC2210
11	3.35	AQMC2211
12	3.65	AQMC2212
13	3.96	AQMC2213
14	4.26	AQMC2214
15	4.57	AQMC2215
16	4.87	AQMC2216
17	5.18	AQMC2217
18	5.48	AQMC2218
19	5.79	AQMC2219
20	6.09	AQMC2220
25	7.62	AQMC2225
28	8.53	AQMC2228
32	9.75	AQMC2232



OEM TYPE REPLACEMENT CONTROL CABLE SELECTION CHART

OEM Engine Cables

(XX) Indicate the cable length you require in feet - **AQMC36(08)** = **AQMC36** (8ft cable)

	Type AQMC5 Mercury 600A Standard	 AQMC5XX	Cable Travel 3"	Thread Size  Engine Specific	Lengths available 8ft - 19ft	
	Type AQMC14 OMC 479 Standard	 AQMC14XX	Cable Travel 3"	Thread Size  Engine Specific	Lengths available 8ft - 18ft	
	Type AQMC36 Standard Mercury Gen II	 AQMC36XX	Cable Travel 3"	Thread Size  Engine Specific	Lengths available 10ft - 21ft	

How to measure for a Replacement Control Cable Control cable length in feet. Round up up to next even foot.

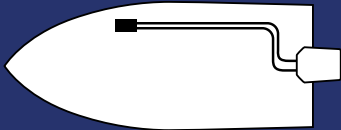

For new installation Outboards

Cable length: measure cable path, add 3ft for engine loop. Round up to next even foot.

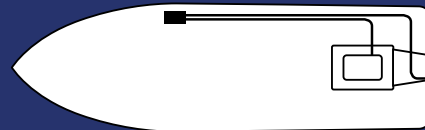

For new installation Sterndrive Inboards

Typical stern drive inboard control cable routing. Cable length: measure cable path and round up to next even foot.

For Replacement of Existing Cable:

If you have removed the old cable, measure the cable as follows: from tip to tip and round up to the next foot. The control cable part number contains its length. AquaFlex cables are usually listed as **AQM??XX**, where **XX** = length in feet. FOR EXAMPLE: Part Number **AQMC1420** = 20 ft.

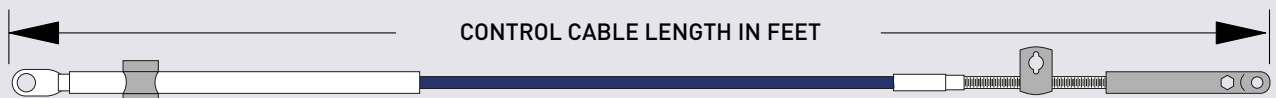

AquaFlex C5 Engine Control Cable

- ◆ Engine control cables compatible with Mercury®, Mariner® and Mercruiser® engines
- ◆ Conduit OD: 8.3mm
- ◆ Jacket colour: Blue
- ◆ Stroke: 95mm (3.75")
- ◆ Lengths available: 8ft (2.4m) to 19ft (5.79m)

Length		Part No:
(ft)	(m)	
8	2.4	AQMC508
9	2.74	AQMC509
10	3.04	AQMC510
11	3.35	AQMC511
12	3.65	AQMC512
13	3.96	AQMC513
14	4.26	AQMC514
15	4.57	AQMC515
16	4.87	AQMC516
17	5.18	AQMC517
18	5.48	AQMC518
19	5.79	AQMC519



AquaFlex C14 Engine Control Cable

- ◆ For BRP® - Evinrude® (OMC®) engines manufactured from 1979 to date
- ◆ Conduit OD: 8.3mm
- ◆ Jacket colour: Blue
- ◆ Stroke: 75mm (3")
- ◆ Lengths available: 8ft (2.4m) to 18ft (5.48m)

Length		Part No:
(ft)	(m)	
8	2.4	AQMC1408
9	2.74	AQMC1409
10	3.04	AQMC1410
11	3.35	AQMC1411
12	3.65	AQMC1412
13	3.96	AQMC1413
14	4.26	AQMC1414
15	4.57	AQMC1415
16	4.87	AQMC1416
17	5.18	AQMC1417
18	5.48	AQMC1418



AquaFlex C36 Engine Control Cable

- ◆ For Mercury® and Mercruiser® engines and Mercury® Generation 11™ series controls.
- ◆ Conduit OD: 8.3mm
- ◆ Jacket colour: Blue
- ◆ Stroke: 87mm (3.4")
- ◆ Lengths available: 10ft (3.04m) to 21ft (6.4m)

Length		Part No:
(ft)	(m)	
10	3.04	AQMC3610
11	3.35	AQMC3611
12	3.65	AQMC3612
13	3.96	AQMC3613
14	4.26	AQMC3614
15	4.57	AQMC3615
19	5.79	AQMC3619
20	6.09	AQMC3620
21	6.40	AQMC3621



What kind of control cables go on my boat? The boat has a [brand name] engine.

There are several ways to determine this information by noting:

- a. **appearance of the cable**
- b. **part number of the cable**
- c. **engine(s) and controls on which cable is used**

Take a look at the existing cable.

Usually, the part number is stamped in white on the existing cable's plastic outer casing.

If you can't locate it or read the part number, check to see what brand of control and brand/year of engine is on the boat.

With this information, you can determine which cable you need from identification/application information.

What kind of ongoing maintenance do cables need? Can they be repaired?

We suggest the following periodic maintenance be performed at least twice a season:

- a. **Check overall operation for proper gear engagement, full and idle throttle, and overall feel.**
- b. **Visually inspect control head cable, as well as engine and transmission cable attachment points for proper tightness of fasteners, correct operation of all moving parts, worn or broken items, cable chafing or misalignment, etc.**
- c. **Do not lubricate core wire (moving wire inside the casing). If the cable operates stiffly, replace it.**
- d. **Keep cable ends dirt and corrosion free.**
- e. **Lubricate pivot points and sliding parts of the cable with a good quality, water-resistant grease.**

When to replace a cable or connection hardware:

- a. **Excessive free play felt at the control even after all cable connections have been verified as in good working order.**
- b. **Visual inspection shows signs of chafing, breakage, bent, loose or worn parts.**

Never attempt to repair a cable. Always replace a malfunctioning cable. A cable cannot be properly repaired in the field and must always be replaced as an assembly. Attempting to repair a cable can result in control system failure, leading to personal injury and/or property damage.

What purpose do control cables serve?

Control cables operate the throttle and gear shift between the control box and engine.

Are outboard control cables universal?

Replacement throttle cables for Mercury®, Mariner® and Evinrude® outboard engines and MerCruiser® inboard engines are generally OEM type cables (C5, C14 & C36) with special end fittings designed to connect to the control box and engine with minimal hardware. Generally, all other engines and control boxes use a "universal" C8 type control cable. For heavier duty applications use a C22 cable.

I have bought a C8 cable, how do I connect it to the engine and control box?

Depending on the condition of the old cable end connectors, they can be removed from the old cable and fitted to the new cable. If the old connectors are not suitable to be reused, consult your local dealer.

How can I check if the old cable ends can be reused?

Start by checking no deterioration to the plastic or metal clip. If this is ok, check there is no damage to the internal thread.

I have a non-genuine manufacturer control box, what cable and cable end do I need?

You will need a C8 cable. For the cable ends you will need to consult with the local engine dealer.

The control cable I have is too long, can I shorten it?

There is no known method of changing the length of a mechanical control cable. Your best option is to purchase new cables of the proper length.

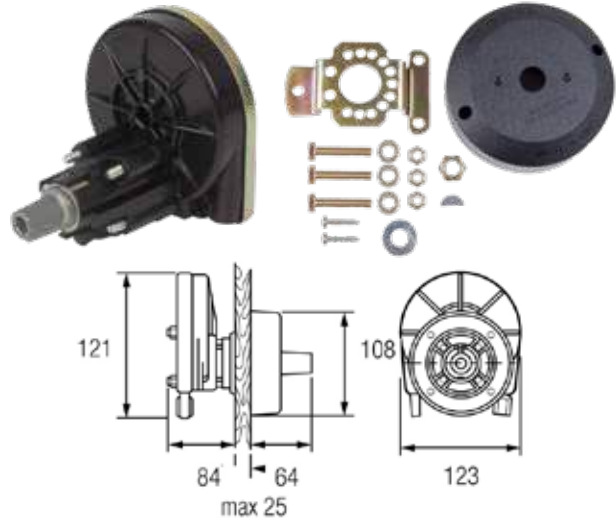

AquaFlex Steering Helm

- ◆ 2.6 turns lock to lock
- ◆ Compact fit behind bulkhead
- ◆ Externally adjustable damper
- ◆ Variable cable approach
- ◆ Includes 90° bezels
- ◆ For outboard engines up to 53hp
- ◆ 3/4" tapered steering shaft

Format	Barcode	Part No:
Boxed	5056228222345	AQM002165

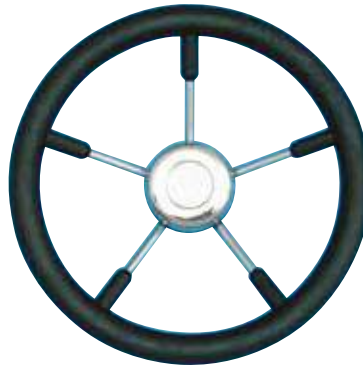

AQM002144



AQM002142

Destroyer Steering Wheel

- ◆ Universal taper hub for AquaFlex, SeaStar, Teleflex, Morse and Ultraflex helms

Type	Dished	Glove	Diameter mm	Material	Format	Barcode	Part No:
5 Spoke	Yes	Black Polyurethane	350	AISI316 Stainless Steel	Boxed with ID Sticker	5056228214786	AQM002144
5 Spoke	Yes	Grey Polyurethane	350	AISI316 Stainless Steel	Bagged with ID Sticker	5056228214779	AQM002142

Classic Steering Wheel

- ◆ Highly durable to resist harsh marine environment
- ◆ Corrosion resistant
- ◆ Made of polypropylene
- ◆ Ergonomic design
- ◆ Widely used in yachts, speedboats, fishing boats and larger vessels
- ◆ Easy installation and easy to store



Description	Colour	Diameter: mm	Format	Barcode	Part No:
3 spoke, fits 37mm tapered shafts	Black	350	Euroslot Carded	5056228215783	AQM002153
3 spoke, fits 37mm tapered shafts	White	350	Euroslot Carded	5056228215776	AQM002152

How to Measure Steering Cables **"MEASURE TWICE. ORDER ONCE."**

Replacement of Existing Rotary Steering Cable:

If possible, find the part number stamped on the plastic jacket of the old cable. If you removed the old cable, measure for the replacement cable as follows:

Measure the plastic cable jacket (Y) in inches, then, add 18 inches to this measurement. Now round this measurement up to the nearest foot. Check the helm and cable type and order that length of cable.

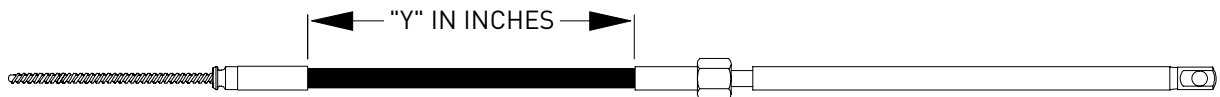

New Installation:

Measure cable routing path from wheel centre line to engine connection, as follows:

- A = Centre line of wheel to gunwale (or deck, if routed downward),**
- B = Dash to transom,**
- C = Gunwale to centreline of cable connection at centred tiller.**

For cable installations through the engine tilt tube: add A, B & C + 6", and round up to the next foot. Order that length cable.

For cables mounted to transom, splashwell or stringer: add A, B & C, then subtract 6" and round up to the next foot. Order that length cable.

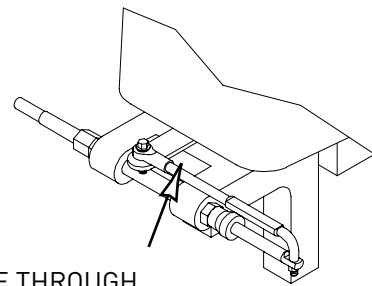

CABLE THROUGH ENGINE TILT TUBE

Typical single station routing:

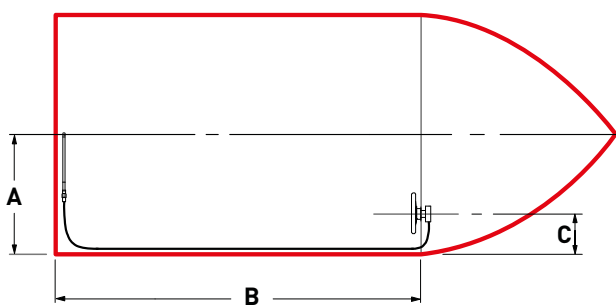

A single-cable, starboard drive push-pull mechanical cable system is shown in this diagram. If your mechanical system is different than the one depicted and/or you have any questions about mechanical steering after reviewing this guide, please contact Bainbridge.

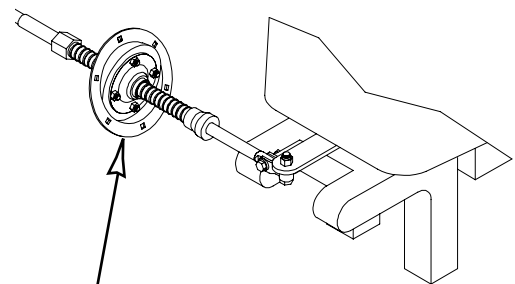

SPLASHWELL CABLE MOUNT

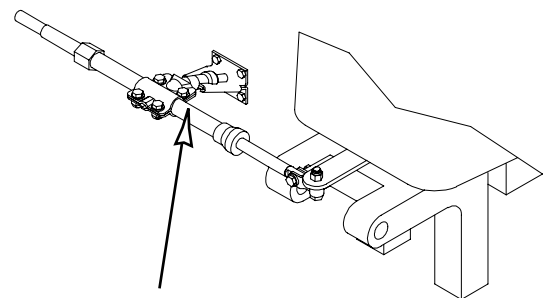

TRANSOM CABLE MOUNT (similar to stringer type)

AquaFlex M58 Steering Cables

- ◆ Steering cable for AquaFlex Steering Helm, Ultraflex Compac-T and Seastar SH8050, C230/231 helms
- ◆ Conduit OD: 13mm
- ◆ Jacket colour: Black
- ◆ Thread end: Nut 7/8" UNF
- ◆ Inner wire: 6mm
- ◆ A range of light duty steering cables suitable for boat engines under 55HP
- ◆ Designed for use with most marine applications from outboard to inboard, making light work of steering in all conditions
- ◆ Lengths available: 7ft (2.13m) to 16ft (4.87m)

(ft)	Length		Part No:
	(ft)	(m)	
7	2.13	AQMM5807	
8	2.4	AQMM5808	
9	2.74	AQMM5809	
10	3.04	AQMM5810	
11	3.35	AQMM5811	
12	3.65	AQMM5812	
13	3.96	AQMM5813	
14	4.26	AQMM5814	
15	4.57	AQMM5815	
16	4.87	AQMM5816	



FAQ's

How do I know which length steering cable I need?

The cable part number and length can usually be found about 2 feet from one end of the cable, stamped into the plastic conduit (exterior jacket or casing). If you can't locate/read it, proceed to step a:

a. Is the cable you are replacing rotary?

Rotary is a spiral wrapped black core wire that sticks out at helm end of cable. The rack and pinion cable has long metal housing with rack [flat] gear inside (under the dash).

Measure the cable's plastic jacket (casing) in inches. If rotary, add 18" and round up to the next foot. If rack & pinion, add 30" and round up to the next foot. Order that length cable.

b. Are you doing a first-time steering cable installation?

Measure cable routing path in boat as follows:

A = Centre line of wheel to gunwale (inches),

B = Dash to transom (inches),

C = Gunwale to cable connection at centred tiller (inches).

For Tilt Tube Mounting, add A, B & C + 6", and round up to the next foot. Order that length cable. For Transom/Splashwell/Stringer Support Mounting, add A, B & C, then subtract 6" and round up to the next foot. Order that length cable.

The steering cable's "core wire" is broken. How can this be repaired?

Steering cables cannot be repaired.

If a steering cable inner core wire separates or breaks within the steering helm (gear box), the steering cable must be replaced with the correct one for the helm.

The helm may need to be replaced as well. Cable breakage within the helm may have caused damage to the gears. A helm cannot be repaired and must be replaced as a unit.

Motor Splashwell Witches Hats – for steering cables

- ◆ Ideally suited for mounting on the transom to splash seal the exit of steering cable from transom



Type	Material	Outer Ring Dia: mm	Inner Dia: mm	Height mm	Barcode	Part No:
Small straight cone type for neat single cable applications	Nylon glass reinforced ring with Dryflex SEPS gaiter	79	51	30	5056228210801	AQM10104
Medium ridged cone type for neat single cable applications	Nylon glass reinforced ring with Dryflex SEPS gaiter	119	86	41	5056228210818	AQM10106
Large ridged cone type for neat single/dual cable applications	Nylon glass reinforced ring with Dryflex SEPS gaiter	139	103	90	5056228210825	AQM10109

Motor Splashwell Grommets/Cable Outlets - for multiple cables

- ◆ Ideally suited for mounting and routing multiple lines to outboards



Type	Material	Outer Ring Dia: mm	Inner Dia: mm	Height mm	Barcode	Part No:
Small flat type with 3 nipples	Nylon glass reinforced ring with Dryflex SEPS gaiter	79	51	10	5056228210795	AQM10103
Medium drawstring type with cable tie	Nylon glass reinforced ring with Dryflex SEPS gaiter	107	73	70	5056228210832	AQM10120



Cable Boot

Description	Colour	Overall Dia: mm	Cut-out Dia: mm	Height: mm	Format	Barcode	Part No:
With screwed ring	Black	105	55	65	Header & Bag	5056228215929	AQM009922
With screwed ring	Black	150	120	110	Header & Bag	5056228215936	AQM009923
Adjustable with screwed ring	Black	105	85	68	Header & Bag	5056228215943	AQM009925

Motor Splashwell Conduit System

- ◆ Designed for use as a 3 part system, this enables really neat installations to be made and allows cables, wires and hoses to be hidden from sight in a really neat convoluted tube. This tube allows flex and free movement as the outboard is steered. Tube is designed to screw into the transom socket and then is cut to length with the rubber reducer slipped on the end of the tube
- ◆ Supplied in individual parts and as a kit



Type	Barcode	Part No:
Transom socket for screwing tube to the transom. Black.	5056228210849	AQM10130
Convoluted tube for steering, control, wires etc. Black 15 metre reel.	5056228210832	AQM10135
Tube end fitting for terminating cables at outboard – push on in Dryflex SEPS material Black	5056228210863	AQM10140
Complete Splashwell Conduit Kit includes: AQM10130, AQM10135 & AQM10140	5056228211365	AQM10141





AQUA MARINE

Quality you can rely on





Bainbridge

Bainbridge International Ltd

8 Flanders Park, Southampton, Hampshire SO30 2FZ UK

T: +44 (0) 1489 776000

E: info@bainbridgeint.co.uk

W: bainbridgmarine.com